

M12 female 0° / RJ45 male 0° shielded Ethernet

PUR 2x2xAWG22 shielded bk UL/CSA+drag chain 20m

Ethernet CAT5

Female straight – male straight

M12 – RJ45, 4-pole

D-coded

shielded

Transmission properties with channel transmission up to 100 m

Further cable lengths on request.

Plastic housings with good resistance against chemicals and oils.

The resistance to aggressive media should be individually tested for your application. Further details on request.

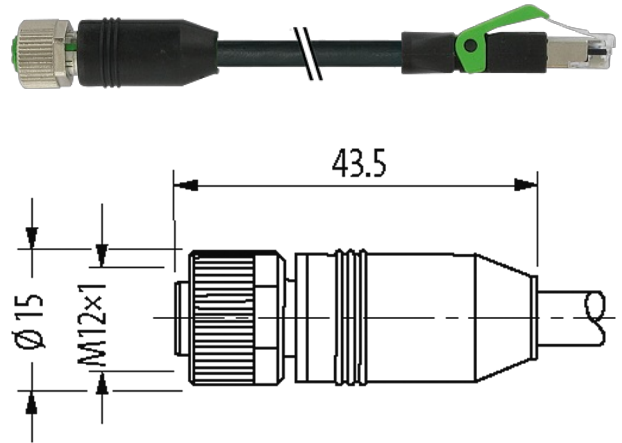
Illustration

Product may differ from Image

Approvals

* only for products with UL/CSA approved cable

More Info

EtherNet/IP



Form

Form 44621

Cables

No./diameter of wires	2 × 2 × 0.34 mm ²
Wire isolation	PO (wh, ye, bl, or)
C-track properties	3 Mio.
Material (jacket)	PUR (UL/CSA)
Outer Ø	6.7 mm ±5%
Bend radius (moving)	12 × outer Ø

Temperature range (fixed)	-40...+80 °C
Temperature range (mobile)	-30...+70 °C
Cable identification	851
Approval (cable)	UL (AWM-Style 20233/11602), CSA; CE
Cable weight [g/m]	69,30
Material (wire)	Cu wire, bare
Resistor (core)	max. 55 Ω/km (20 °C)
Construction (core)	7 × 0.254 mm
Diameter (core)	2 × 2 × AWG22
AWG	similar to AWG 22
Material (wire isolation)	PO
Wire-Ø incl. isolation	1.4 mm ±5%
Color/numbering of wires	wh, ye, bl, or
Shield	yes
	min. 85%
Material (jacket)	PUR
Outer-Ø (jacket)	6.7 mm ±5%
Color (jacket)	black
chemical resistance	good resistance to oil, gasoline and chemicals
thermal resistance	flame retardant
Nominal voltage	300 V
Temperature range (fixed)	-40...+80 °C
Temperature range (mobile)	-30...+70 °C
Bend radius (fixed)	5 × outer Ø
Bend radius (moving)	12 × outer Ø
Traversing distance (C-track)	max. 5 m (horizontal)
Travel speed (C-track)	max. 3.3 m/s
Acceleration (C-track)	max. 2 m/s ²
Jacket Color	black

Technical Data

Operating voltage	max. 60 V DC
Operating voltage (only UL listed)	30 V DC
Rated surge voltage	1.0 kV
Operating current per contact	max. 1.5 A
Transfer parameters	CAT5, Class D (ISO/IEC 11801:2002), (EN 50173-1)
Transfer rate	up to 100 Mbit/s full duplex
Material group	IEC 60664-1, category I
Coding	D-coded
LED display	no
Locking of ports	Screw thread (M12×1 mm) recommended torque 0.6 Nm, self-securing
Compression gland	M12 (SW13)
Protection	IP67 (M12) - IP20 (RJ45)
Locking material	Zinc die casting, matte nickel plated
Material	PUR
suitable for corrugated tube (internal Ø)	without

General data

Standards	DIN EN 61076-2-101 (M12)
Mounting method	inserted, tightened
Material (gasket)	FKM
Pollution Degree	3

Temperature range -25...+85 °C, depending on cable quality

Commercial data

country of origin	DE
customs tariff number	85444290
EAN	4048879678964
eClass	27061801
Packaging unit	1

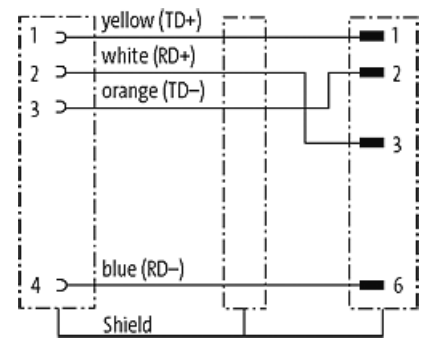
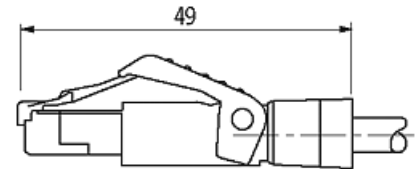
Sketch

Product may differ from Image